

Pedals PD-EF202

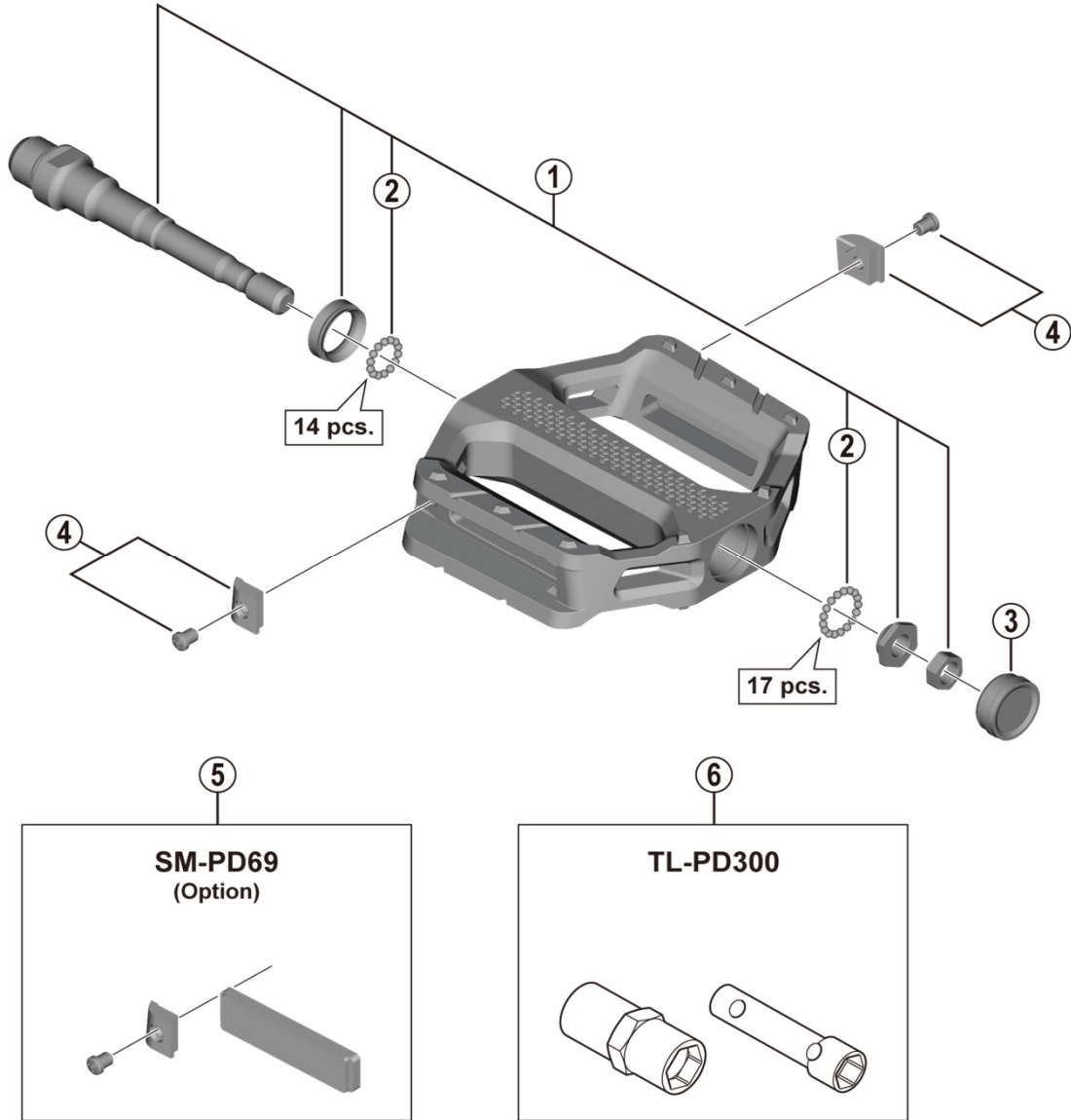

ITEM NO.	SHIMANO CODE NO.	DESCRIPTION	INTERCHANGEABILITY		
			PD-EF202	PD-M324	PD-M505
1	YL8S98010	Pedal Axle Assembly (Right / B.C.9/16" x 20T.P.I.)	A		
	YL8S98020	Pedal Axle Assembly (Left / B.C.9/16" x 20T.P.I.)	A		
2	Y41N98030	Steel Ball (3/32") 62 pcs.	A	A	A
3	YL8R05000	Cap	A	B	B
4	YL8S98030	Reflector Fixing Screw & Plate (Right)	A		
	YL8S98040	Reflector Fixing Screw & Plate (Left)	A		
5	YL8S98050	SM-PD69 Reflector Unit (4 pcs. / Option)	A		
6	Y40098010	TL-PD300 Cone Adjusting Tool Set	A	A	A

A: Same parts.

B: Parts are usable, but differ in materials, appearance, finish, size, etc.

Absence of mark indicates non-interchangeability.

Specifications are subject to change without notice.

Jun.-2020-4722

© Shimano Inc. I

SHIMANO